

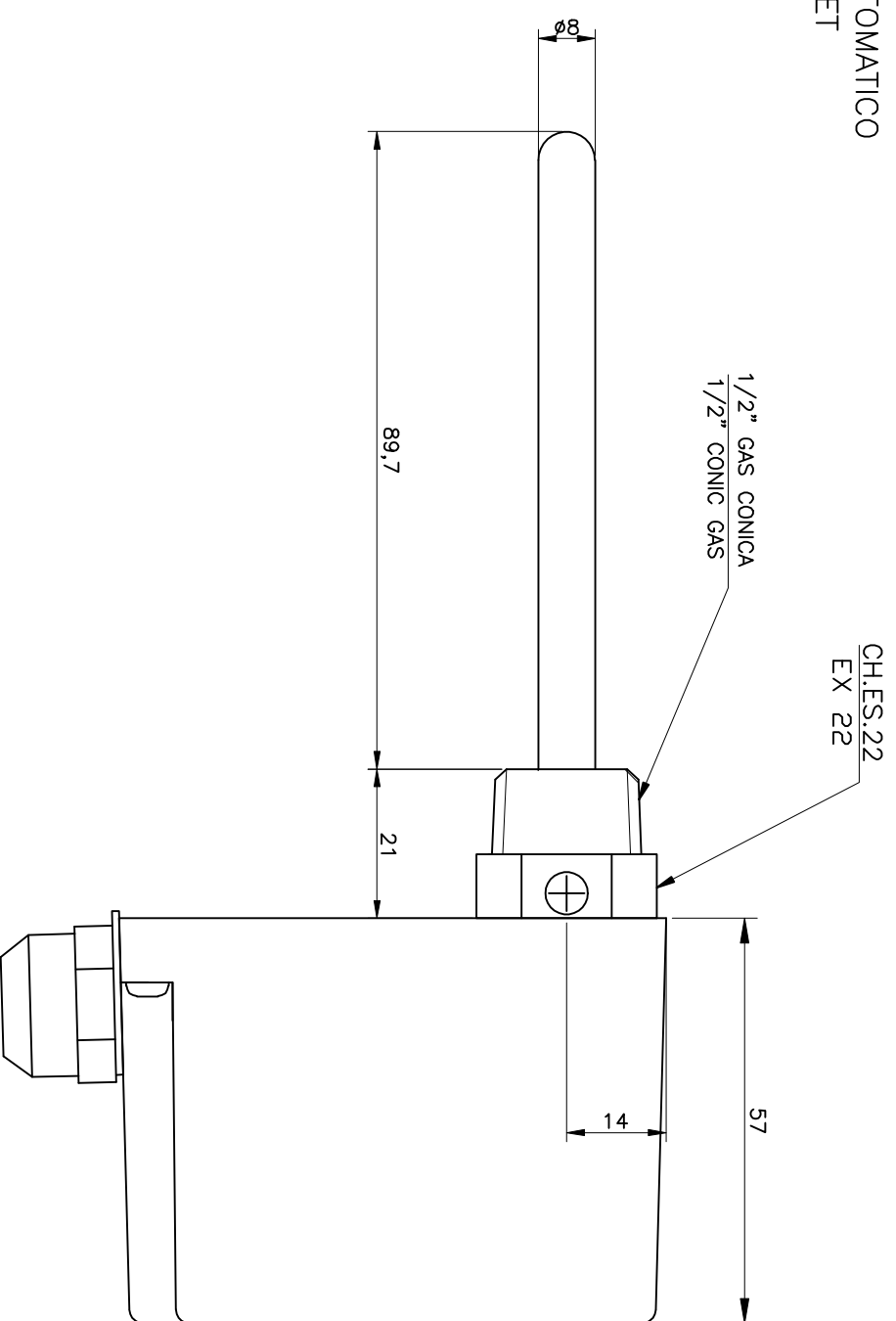

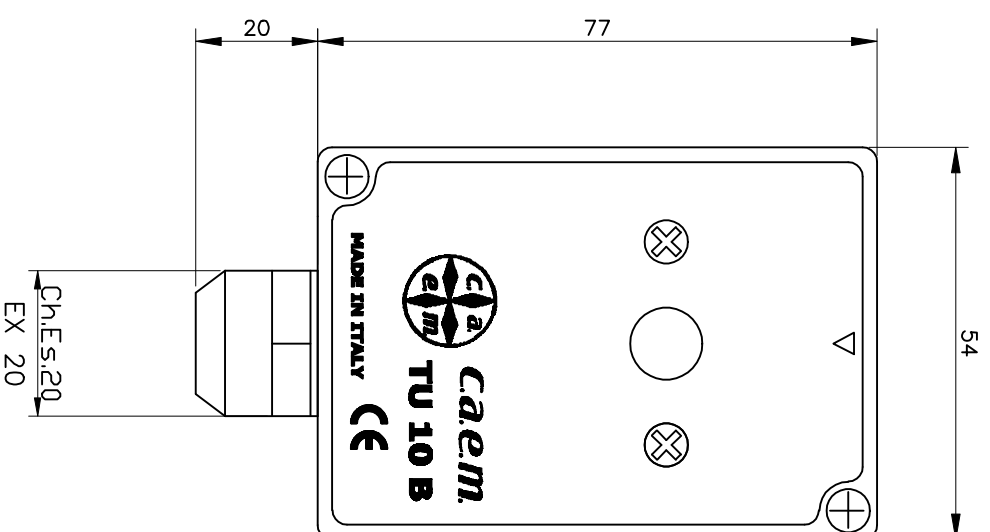

TERMOSTATO MOD. TU-10 B TARATURA FISSA RIARMO AUTOMATICO
 THERMOSTAT MOD. TU-10 B FIX SETTING AUTOMATIC RESET



OMOLOGAZIONE :  **CE**
 TEMPERATURA DI INTERVENTO SU RICHIESTA DEL CLIENTE
 TARATURA IN BAGNO NORMALIZZATO
 TERMINALI FASTON 6.3 mm CON MORSETTI A VITE
 T80
 ISOLAMENTO CLASSE II 

APPROVALS  **CE**
 CALIBRATION ON CUSTOMER REQUEST
 CALIBRATION IN NORMALIZED BATH
 TABS TYPE 1/4" WITH SCREW TERMINALS
 T80
 INSULATION CLASS II 

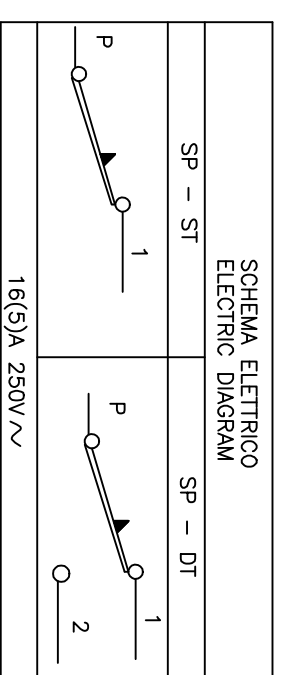

COLORI . SCATOLA : MARRONE, BIANCA, ARANCIONE
 COLOURS . BOX : BROWN, WHITE, ORANGE